

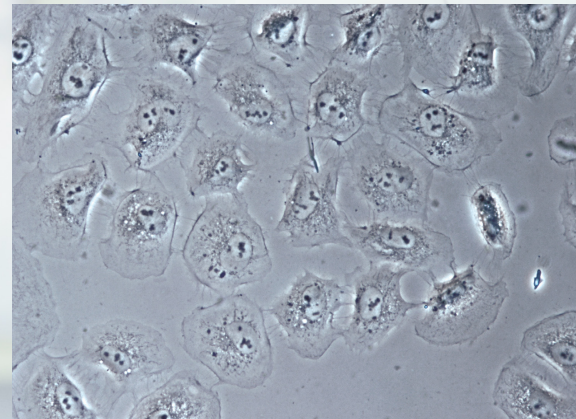

Biological Microscope
ECLIPSE
E100

LED
Illumination

High-quality images with newly developed bright LED illumination and time-proven CFI optical system

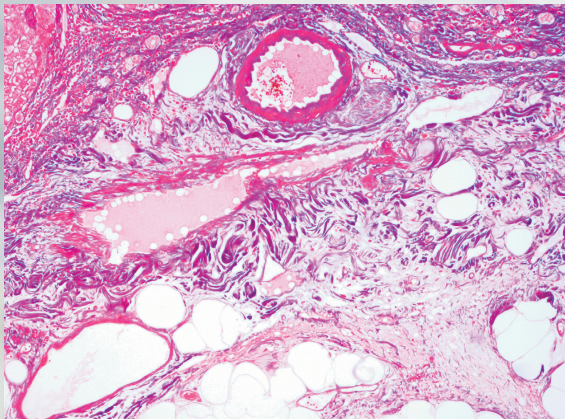

High-intensity LED Eco-illumination

The newly developed Eco-illumination provides enough brightness for phase contrast observation. With a fly-eye lens in the illuminator, uniform brightness is provided in the entire field of view. Using environmentally friendly long-life LEDs, Eco-illumination boasts a long lifetime of 60,000 hours and reduces the need for frequent lamp replacement. A halogen illumination model is also available.

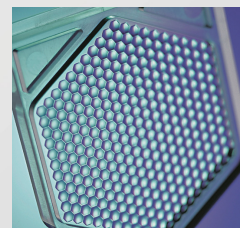

Fly-eye lens

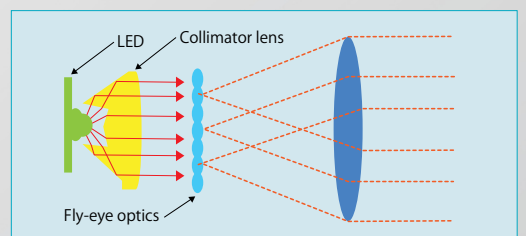
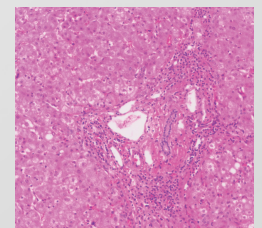

Features newly developed high-intensity LED illumination, providing uniform brightness in the entire field of view. A halogen illumination model is also available.

Nikon's infinity corrected optics, designed especially for the ECLIPSE E100 microscope, use state-of-the-art technology to produce outstanding performance. Nikon's CFI* optics achieve flat, sharp images that minimize distortion to the maximum. Colorless transparent specimens can be observed with phase contrast observation. Featuring a simple and easy-to-use design for beginners, strong rigidity to ensure high accuracy and a long life, and an easy-to-store structure, the ECLIPSE E100 is the perfect choice for a variety of purposes, including educational and routine laboratory research.

*Chromatic-aberration Free Infinity



Objectives for flat images

Nikon has developed the CFI BE Plan objectives, which feature superior image flatness, exclusively for the E100. Chromatic aberration and field curvature are corrected over the entire field of view. Images are clear and bright at every magnification. The E100 provides first class optical quality at a modest price.

Anti-mold design

Anti-mold paint and an anti-mold tablet are used in the objectives, eyepieces and tubes to prevent mold forming in high-humidity environments.

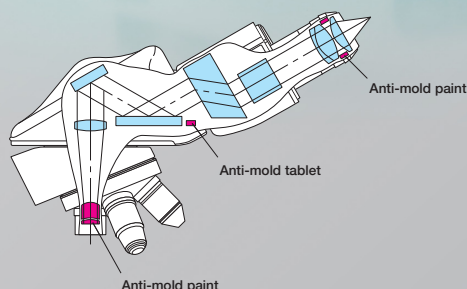

Ergonomic design

Compact, lightweight body with enhanced operability—providing ease of use

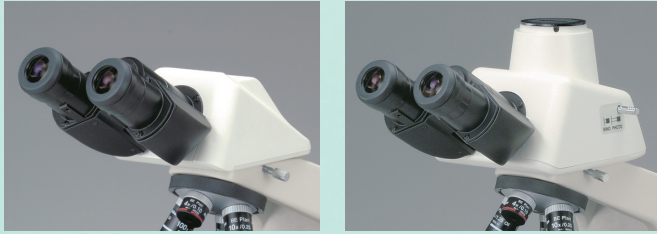

Binocular and trinocular tubes available

The ECLIPSE E100 employs a Siedentopf-type tube that provides a constant and accurate tube length. Both binocular and trinocular tubes are available. A digital camera can be attached to the trinocular tube.*

*See "Tube" on page 6.

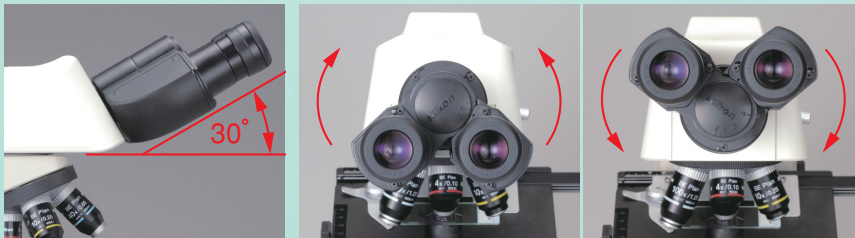

Observation with comfort

The tube is inclined at 30°, allowing comfortable viewing in a natural posture. By simply swinging the front part of the tube, the user can change the eyepoint height. With a pupillary distance is 64 mm, for example, it can be moved 34 mm upwards or downwards. In addition, the interpupillary distance adjustment and the diopter adjustment ring are designed to accommodate a wide range of operators.

Smooth rotation quadruple nosepiece

The high-quality revolving nosepiece has a superior internal detent click-stop mechanism. A knurled elastic covered grip around the base of the nosepiece makes the nosepiece easy to rotate and eliminates the need to touch the objectives.

Double-plate mechanical stage

The built-in stage has a double-plate mechanism with an XY dual travel control. The large, flat stage surface facilitates easy specimen handling. Because the height of the X-axis guide rail is level with the stage surface and the stage surface is flat and smooth, glass slides move easily over the surface. A spring-loaded slide holder is included.



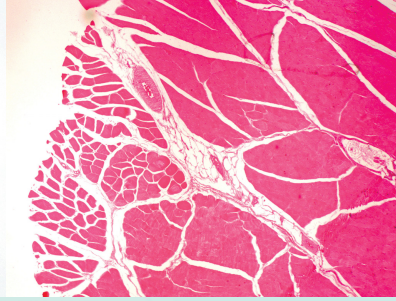
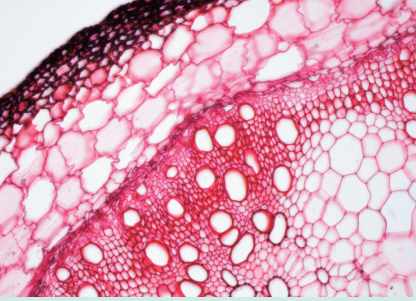

Condenser with position guide markings

The condenser comes with an aperture diaphragm with position guide markings for the 4x, 10x, 40x, 60x and 100x objectives to make operations quick and easy, ensuring perfect specimen images. The condenser position can also be adjusted (Simplified Kohler's Illumination System).

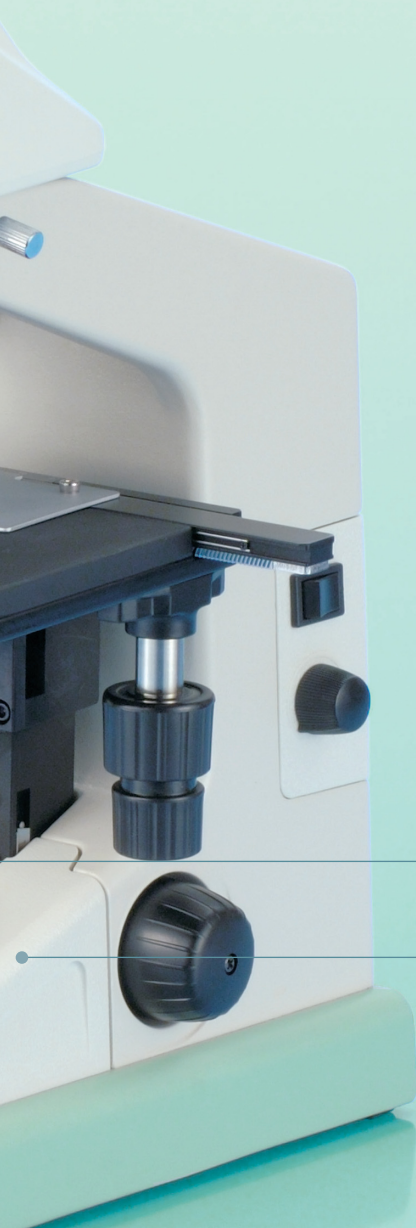

Coaxial coarse/fine focus knob

The coaxial coarse/fine focus knob is comfortably located at desk-height level. The focus knob and the stage handle are ergonomically designed and are located equidistant from the operator, meaning they can both be easily adjusted from a normal sitting position. In addition, the torque of the coarse focus knob can be adjusted.

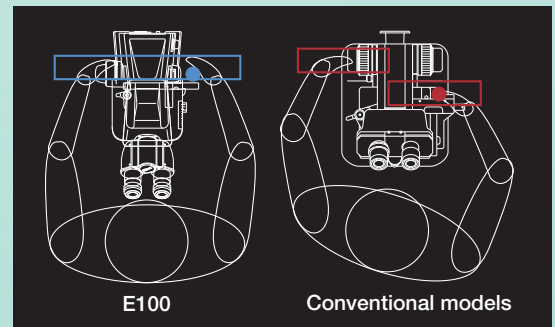

Comparison of the positions of the stage handle and focus control knob

Easy halogen lamp replacement

The halogen illumination model features a powerful 6V20W halogen lamp that is adjustable up to 6 V for convenient illumination control. Replacing the lamp is easy and trouble-free. Simply detach the field lens unit and replace.



Convenient for transportation and storage

The microscope body is compact and lightweight. A cord hanger and storage case are available to make transporting and storing the E100 easier.



Accessories corresponding to a wide variety of applications

Phase contrast attachment

Simple phase contrast observation at 10x and 40x is possible with a single phase annulus slider. The aperture diaphragm automatically opens when the slider is inserted into the condenser. A phase contrast 100x slider and darkfield ring stop for 10x, 20x and 40x objectives are available as options.

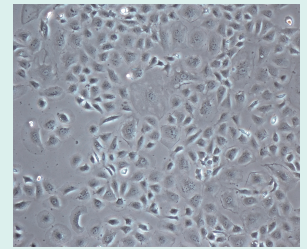

Mirror unit

A mirror unit is available for observation where there is no access to a power source. Removal of the FL (field lens) unit and insertion of the mirror unit in its place is easy.



Tube

Siedentopf-type binocular and trinocular tubes are available. A digital camera can be attached to the trinocular tube.*

*With a 4x objective, the image may show uneven illumination depending on the camera used.



Condenser

An Abbe condenser for brightfield observation and a phase condenser for phase contrast and darkfield observations are available.



Cord hanger

The power cord can be simply wound up when not in use.



Storage case

Available in both wood and aluminum, the dedicated storage case is handy for transporting and storing the E100.



Digital Sight series camera system

When the trinocular tube is used, a digital camera can be attached.* The DS-Vi1-L3, a color camera head combined with a standalone control unit, enables focusing and viewing of images on the built-in 8.4-inch LCD monitor without the need for a PC. The optimum imaging conditions that match the observation technique in use can be automatically set by selecting the appropriate "scene mode" icon on the touch panel. Storing optimal images is easy.

*See "Tube" on page 6.



System diagram

System diagram

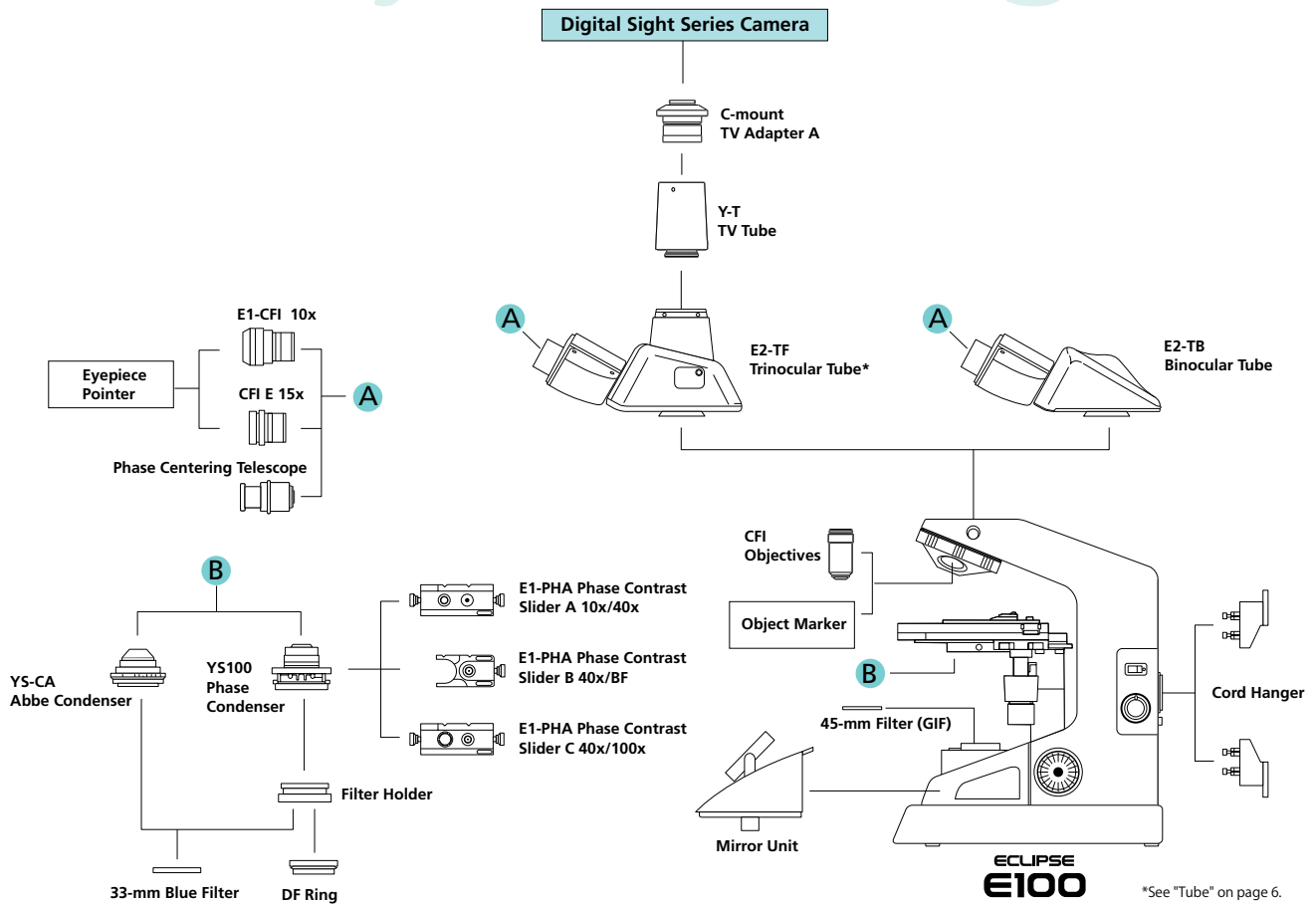

Specifications

Main body	
Optical system	CFI Infinity Optical System, Simplified Kohler's Illumination System
Illumination	High luminescent white LED illuminator (Eco-illumination) 6V20W halogen lamp, Compliant multi-voltage (100 V-240 V)
Eyepieces (F.O.V.) (anti-mold)	With diopter adjustment <ul style="list-style-type: none"> • E1-CFI 10x (18 mm) • CFI E 15x (12 mm)
Focusing	Coaxial coarse/fine focusing, Cross roller guide, Focusing stroke: 22 mm, Coarse: 37.7 mm/rotation, Fine: 0.2 mm/rotation, Coarse motion torque adjustable
Tubes (anti-mold)	Interpupillary distance adjustment: 47 mm to 75 mm, Inclination angle: 30°, 360° rotatable <ul style="list-style-type: none"> • E2-TB Binocular Tube • E2-TF Trinocular Tube, Eyepiece/Port: 100/0, 0/100
Nosepieces	Quadruple nosepiece (within main body), Revolving mechanism with multiple ball bearings, Elastic nosepiece grip-ring
Stages	Rectangular mechanical stage (within main body), with specimen holder, with vernier calibrations, Cross travel: 76 (X) x 40 (Y) mm, Stage size: 150 (W) x 134 (D) x 16 (H) mm
Objectives (NA / W.D., mm) (anti-mold)	<ul style="list-style-type: none"> • CFI BE Plan Achromat 4x (0.1 / 25) • CFI BE Plan Achromat 10x (0.25 / 6.7) • CFI BE Plan Achromat 20x (0.4 / 3.7) • CFI BE Plan Achromat 40x (0.65 / 0.6) • CFI BE Plan Achromat 60x (0.8 / 0.24) • CFI BE Plan Achromat 100x (1.25 / 0.14) • CFI BE Plan Achromat DL10x (0.25 / 6.7) • CFI BE Plan Achromat DL40x (0.65 / 0.6) • CFI BE Plan Achromat DL100x (1.25 / 0.14)
Condensers	<ul style="list-style-type: none"> • YS-CA Abbe Condenser N.A. 1.25, Aperture diaphragm with position guide marking for respective objectives, 33-mm Blue Filter attachable • YS100 Phase condenser (optional)
Observation methods*	Brightfield, Darkfield, Phase contrast
Optional accessories	Phase contrast attachment, Object marker, Darkfield ring unit, Mirror unit, Cord hanger, Storage case
Power consumption (max.)	Normal value: 3 W (LED model), 33 W (halogen model)
Weight (approx.)	6 kg (Binocular standard set)

*Observations except brightfield require optional accessories.

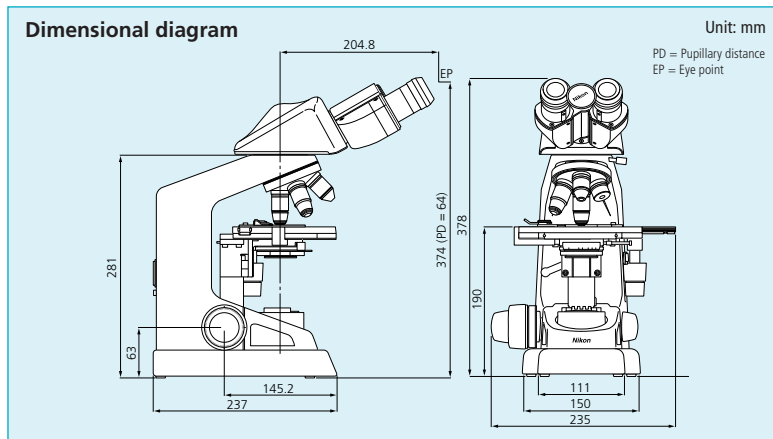

Specifications and equipment are subject to change without any notice or obligation on the part of the manufacturer. June 2015 ©2006-15 NIKON CORPORATION



WARNING

TO ENSURE CORRECT USAGE, READ THE CORRESPONDING MANUALS CAREFULLY BEFORE USING YOUR EQUIPMENT.

Monitor images are simulated.

Company names and product names appearing in this brochure are their registered trademarks or trademarks. N.B. Export of the products* in this brochure is controlled under the Japanese Foreign Exchange and Foreign Trade Law. Appropriate export procedure shall be required in case of export from Japan.

*Products: Hardware and its technical information (including software)



ISO 9001 Certified
for NIKON CORPORATION
Microscope Solutions Business Unit
Industrial Metrology Business Unit



ISO 14001 Certified
for NIKON CORPORATION



NIKON CORPORATION

Shinagawa Intercity Tower C, 2-15-3, Konan, Minato-ku, Tokyo 108-6290, Japan
phone: +81-3-6433-3705 fax: +81-3-6433-3785
<http://www.nikon.com/instruments/>

NIKON INSTRUMENTS INC.

1300 Walt Whitman Road, Melville, N.Y. 11747-3064, U.S.A.
phone: +1-631-547-8500; +1-800-52-NIKON (within the U.S.A. only)
fax: +1-631-547-0306
<http://www.nikoninstruments.com/>

NIKON INSTRUMENTS EUROPE B.V.

Tripolis 100, Burgerweeshuispad 101, 1076 ER Amsterdam, The Netherlands
phone: +31-20-7099-0000 fax: +31-20-7099-298
<http://www.nikoninstruments.eu/>

NIKON INSTRUMENTS (SHANGHAI) CO., LTD.

CHINA phone: +86-21-6841-2050 fax: +86-21-6841-2060
(Beijing branch) phone: +86-10-5831-2028 fax: +86-10-5831-2026
(Guangzhou branch) phone: +86-20-3882-0550 fax: +86-20-3882-0580

NIKON SINGAPORE PTE LTD

SINGAPORE phone: +65-6559-3651 fax: +65-6559-3668

NIKON INSTRUMENTS KOREA CO., LTD.

KOREA phone: +82-2-2186-8400 fax: +82-2-555-4415

NIKON CANADA INC.

CANADA phone: +1-905-602-9676 fax: +1-905-602-9953

NIKON FRANCE S.A.S.

FRANCE phone: +33-1-4516-45-16 fax: +33-1-4516-45-55

NIKON GMBH

GERMANY phone: +49-211-941-42-20 fax: +49-211-941-43-22

NIKON INSTRUMENTS S.p.A.

ITALY phone: +39-55-300-96-01 fax: +39-55-30-09-93

NIKON AG

SWITZERLAND phone: +41-43-277-28-67 fax: +41-43-277-28-61

NIKON UK LTD.

UNITED KINGDOM phone: +44-208-247-1717 fax: +44-208-541-4584

NIKON GMBH AUSTRIA

AUSTRIA phone: +43-1-972-6111-00 fax: +43-1-972-6111-40

NIKON BELUX

BELGIUM phone: +32-2-705-56-65 fax: +32-2-726-66-45